

# WWS

Wheel and axle weighing platforms

USER MANUAL

ENGLISH

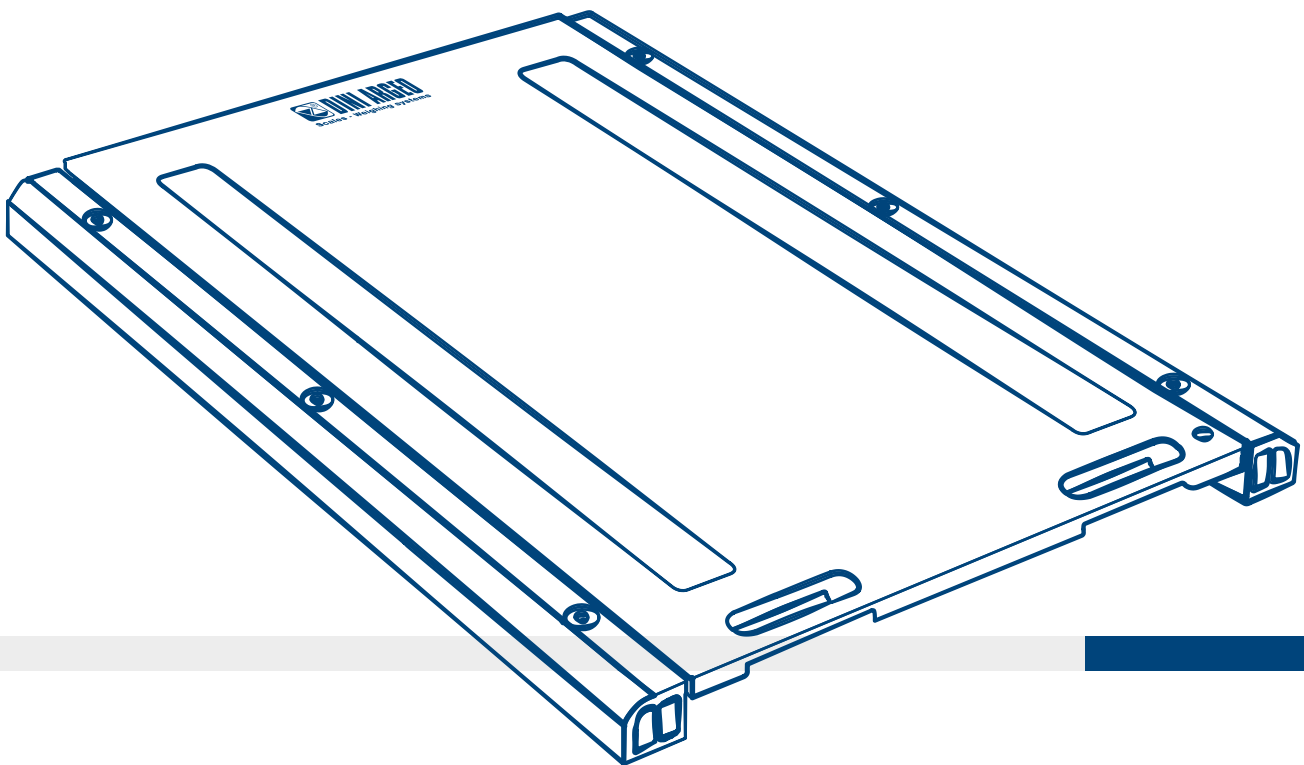



# FUNCTION INDEX

<b>Introduction</b>	<b>4</b>
Safety information - Warnings	4
Technical features of the platform with cable	5
Technical features of the wireless platform	5
The range of WWS platforms	5
Definition of the wheel-weighing system	7
Definition of the axle-weighing system	7
<b>Main setups</b>	<b>9</b>
Two platforms	9
Three platforms	9
Four platforms	9
Five platforms	10
From six to ten platforms	10
Over 10 platforms (wireless version only)	11
Single “dual” setup	11
<b>Installing the platforms</b>	<b>12</b>
Choosing the weighing area	12
How to position the platforms	13
How to position and connect the cables	14
How to position the wireless platforms	14
How to use the platforms correctly	15
<b>Maintenance of the platforms</b>	<b>16</b>
Checking the correct operation of the scales	16
Periodical maintenance and cleaning of the weighing area	16
<b>Accessories</b>	<b>17</b>
Levelling modules for axle-weighing systems	17
Choosing the length of the area levelled with the modules	17
Pit frames for floor-level installations	18
Additional ramps for easier up/down movements	18
<b>Weighing of objects or structures</b>	<b>19</b>
<b>FAQ - Frequently Asked Questions</b>	<b>20</b>
<b>Messages and errors</b>	<b>20</b>
Messages of the wireless platforms	20

Dear customer,

Thank you for choosing a DINI ARGEO weighing system.

The WWS platforms are weighing units that when operated in unison, provide a system to weigh vehicles/objects/structures with several support points of any size and capacity.

Thanks to the quality materials and top specifications, these platforms provide accuracy and optimal performance over time.

The operating features of WWS platforms are patented.

## Safety information - Warnings

The safety precautions described in this manual, marked with the  symbol, must be followed during all installation, use, maintenance or repair of the weighing system.

Any use other than those reported in this manual, along with failure to follow the safety precautions, shall relieve the manufacturer from any responsibility and will void the product warranty.



- Carefully read this manual before performing any action.
- The platforms must not be tampered with by the user for any reason or this will void the warranty.
- Avoid prolonged immersions of the platform.
- Do not expose the platforms to heat sources.
- Do not install in environments at risk of explosion (except for specific versions).
- All tool connections must be made by following applicable standards in the installation area and environment.
- Do not disassemble or tamper with the platforms.
- Do not overload the platforms beyond the maximum declared load.
- Clean the platform with non-aggressive substances and avoid solvents.
- Anything not specifically described in this manual is to be considered as improper use of the equipment.

## Technical features of the platform with cable

- Special aluminium alloy loading platform.
- Built-in up/down ramps
- Watertight stainless steel load cells, OIML type-approved, oversized.
- Watertight connections.
- Specific cable for mobile applications.
- Spirit level.
- Non-slip base made with special vulcanised rubber.
- Wheels for easier transport and positioning.

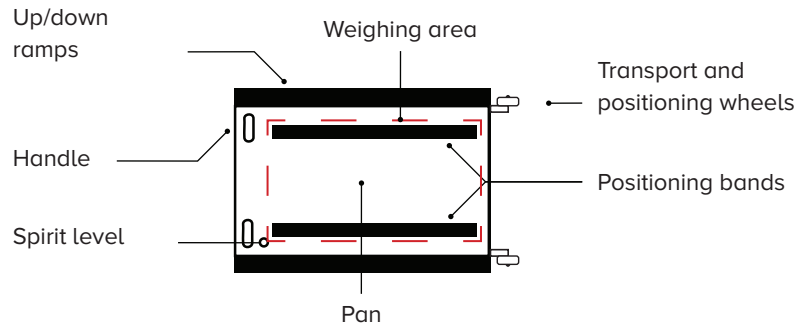

## Technical features of the wireless platform

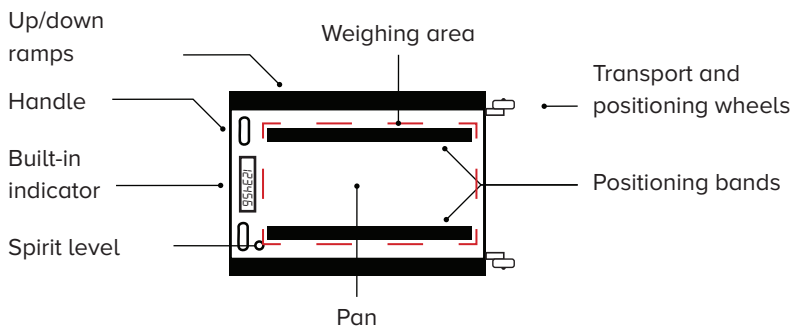

- Built-in indicator provided as standard with a unit to transmit data to the main indicator.
- Special aluminium alloy loading platform.
- Built-in up/down ramps
- Watertight stainless steel load cells, OIML type-approved, oversized.
- Watertight connections.
- Spirit level.
- Non-slip base made with special vulcanised rubber.
- Wheels for easier transport and positioning.

## The range of WWS platforms

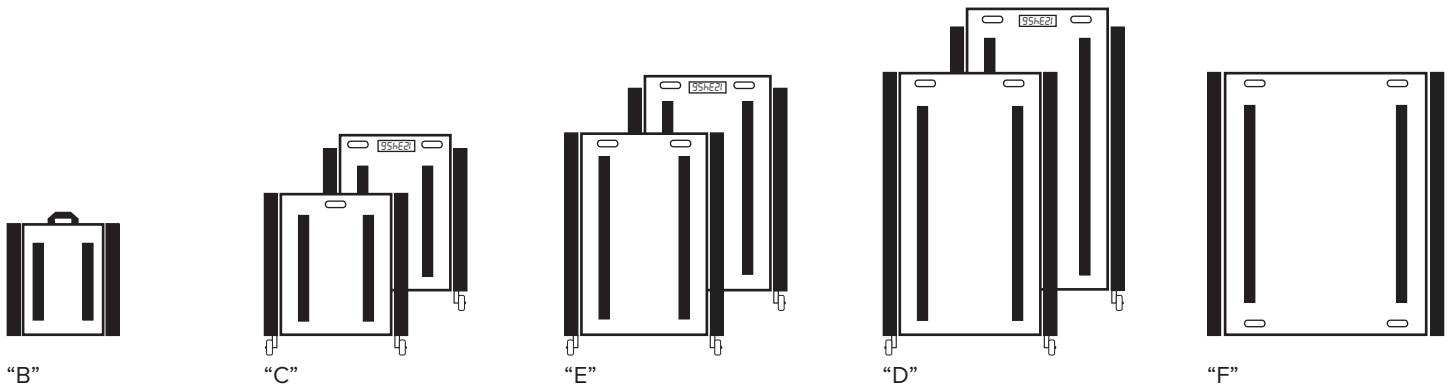

### Analog

Pan dimensions  
400x300 mm  
Weighing area  
300x215 mm

Pan dimensions  
500x400 mm  
Weighing area  
400x315 mm

Pan dimensions  
700x450 mm  
Weighing area  
600x365 mm

Pan dimensions  
900x500 mm  
Weighing area  
750x415 mm

Pan dimensions  
900x700 mm  
Weighing area  
750x515 mm

### Radio

Pan dimensions  
565x400 mm  
Weighing area  
400x315 mm

Pan dimensions  
750x450 mm  
Weighing area  
600x365 mm

Pan dimensions  
950x500 mm  
Weighing area  
750x415 mm

## Display features

The display shows the weight on the platform. In the event of a type-approved system that is radio-connected for legislative reasons, individual platforms will not show the weight, but the platform number associated with it (PL1, PL2, PL3, etc.)



Internal battery charge level indicator:



Charged battery



Low battery

The **LoB.bAtt** message precedes automatic instrument switching off.

At the first switch-on, make sure you charge the battery for at least 12h by using the supplied charger.



Unstable weight, it cannot be acquired in manual mode.



When the scale is unloaded, the weight is zero, which is correct.



Indicates the scale active in the dual configuration (see page 10):



“Scale 1”



“Scale 2”



Sum of “Scale 1” + “Scale 2”

## Keyboard features

ON/OFF



Turns on the platform.

ON/OFF



3 sec.

Turns off the platform.

ZERO





Resets the weight within 2% of the maximum capacity.

ZERO



PRINT



If the automatic keylock is active, press  and  one after the other to unlock the keypad.

## Definition of the wheel-weighing system

### USE

A wheel-weighing system consists of as many platforms as many vehicle wheels to be weighed and is used to weigh the whole vehicle in a single step.

A wheel-weighing system provides the following benefits:

- weighing accuracy comparable to that of a weighbridge (0.05% end-of-scale);
- less expensive than a weighbridge and no masonry work is required;
- display and printing of the weight of the single wheels, all combinations (axles, right side, left side, front, back, etc.) and the total weight of the vehicle;
- calculation of the centre of gravity of the vehicle (depending on the setup).

1. Drive onto the platforms, engage the first gear, stop the engine and release the brake.

2. Acquire the weight  
(refer to the user manual of the main indicator).

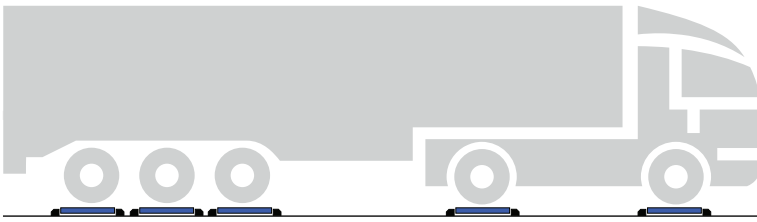

## Definition of the axle-weighing system

### USE

An axle-weighing system consists of two platforms and is used to weigh the whole vehicle by adding together the various axles.

An axle-weighing system provides the following benefits:

- overload control on the axle;
- easy to install and use;
- display and print-out of the axle weight and total weight.

### Manual static axle weighing

Each axle is acquired when the dedicated button is pressed. System that can be made with both wireless and wired platforms.

1. Drive onto the platform and stop there.

2. Acquire the weight  
(refer to the user manual of the main indicator).

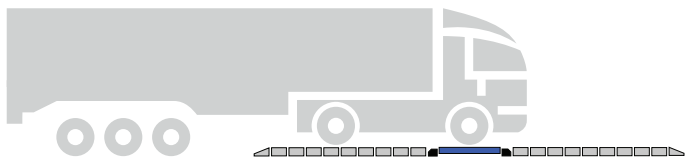

To achieve the best weighing accuracy, while acquiring the weigh, release the parking brake and turn off the engine. If the vehicle has self-levelling suspensions, disable them or use levelling modules. Place the wheels at the centre of the signalling strips on the loading platform.

## Automatic dynamic axle weighing

Each axle is automatically acquired as the vehicle passes over the platforms. System that can only be made with wired platforms.

1. Pass on the platform at low speed.

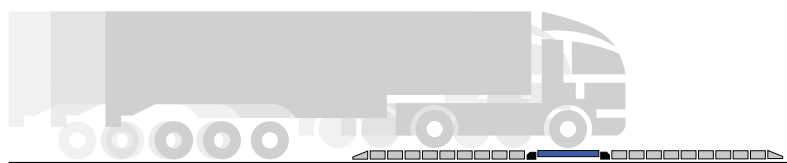

2. The weight acquisition takes place dynamically and automatically.



Pass at the lowest possible speed and ensure this is constant (5 mph). Do not brake during the weighing process. Throughout the weighing cycle, we recommend ensuring all wheels are at the same level, by using levelling modules or pit frames to achieve the optimal weighing performance. The minimum recommended length of a flat surface must be at least twice that of the longest vehicle to be weighed (see page 16).



## Two platforms

### APPLICATIONS

Weighing each axle of the vehicle or trailers with one axle.

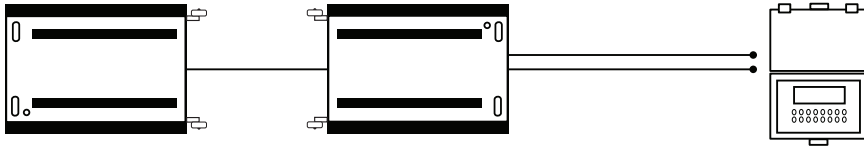

Available both in a wired and wireless version.

## Three platforms

### APPLICATIONS

Weighing small planes, three-wheeled vehicles or trailers with a support pin.

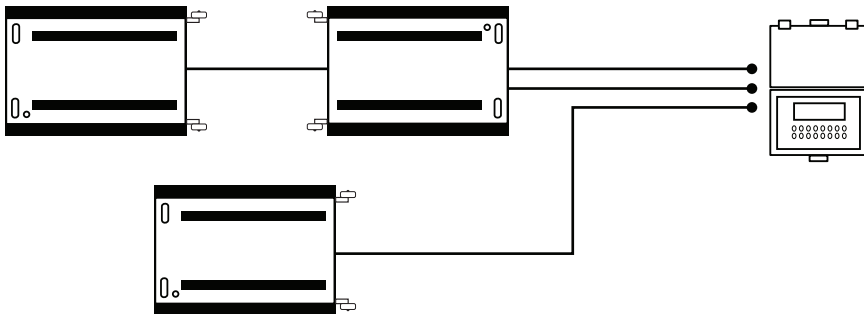

Available both in a wired and wireless version.



The size and capacity of the third platform can differ from those of the other platforms.

## Four platforms

### APPLICATIONS

Weighing vans, cars, trailers, containers or other items with four support points.

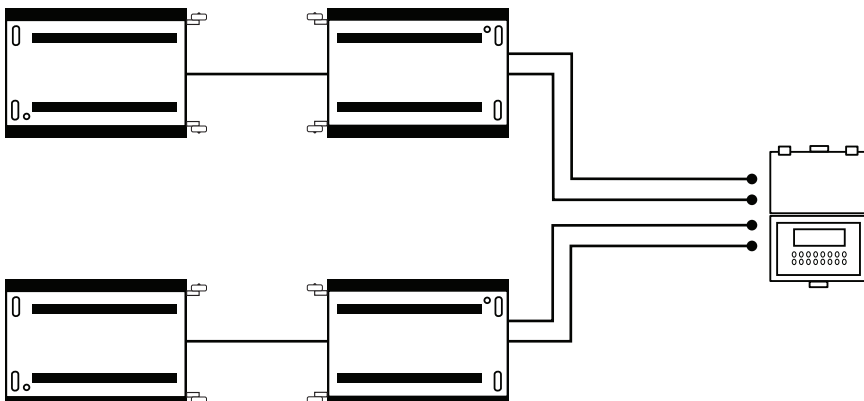

Available both in a wired and wireless version.

# Five platforms

**APPLICATIONS** Weighing two-axle trailers with a support pin.

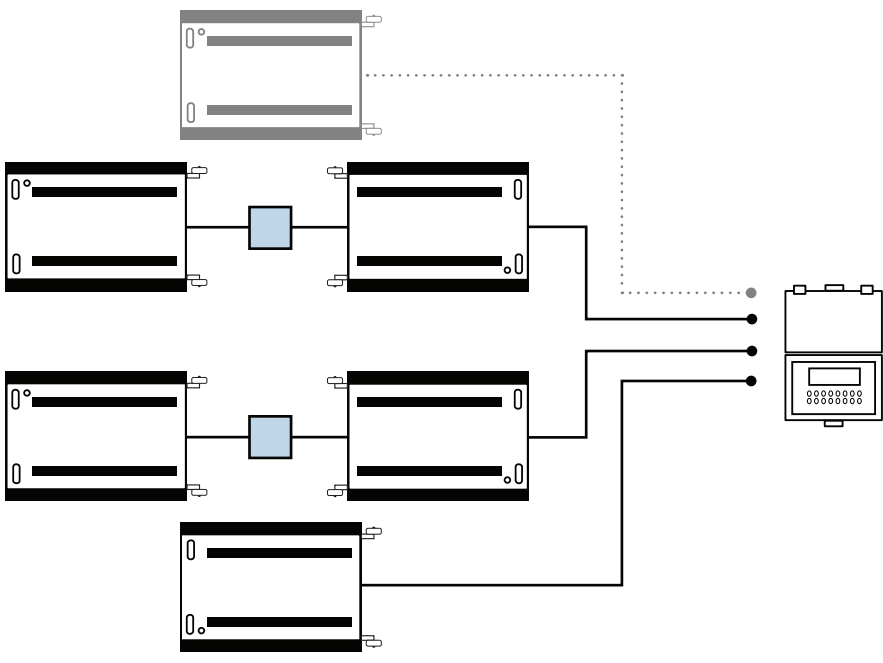

**i** Available in wired and wireless versions.

**i** When you need to weigh both ways, we recommend adding a sixth platform, placed as shown in the figure.

**i** The size and capacity of the fifth platform can differ from those of the other platforms.

 = Junction box

# From six to ten platforms

**APPLICATIONS** Weighing vehicles from three to five axles or structures with several support points in a single step.

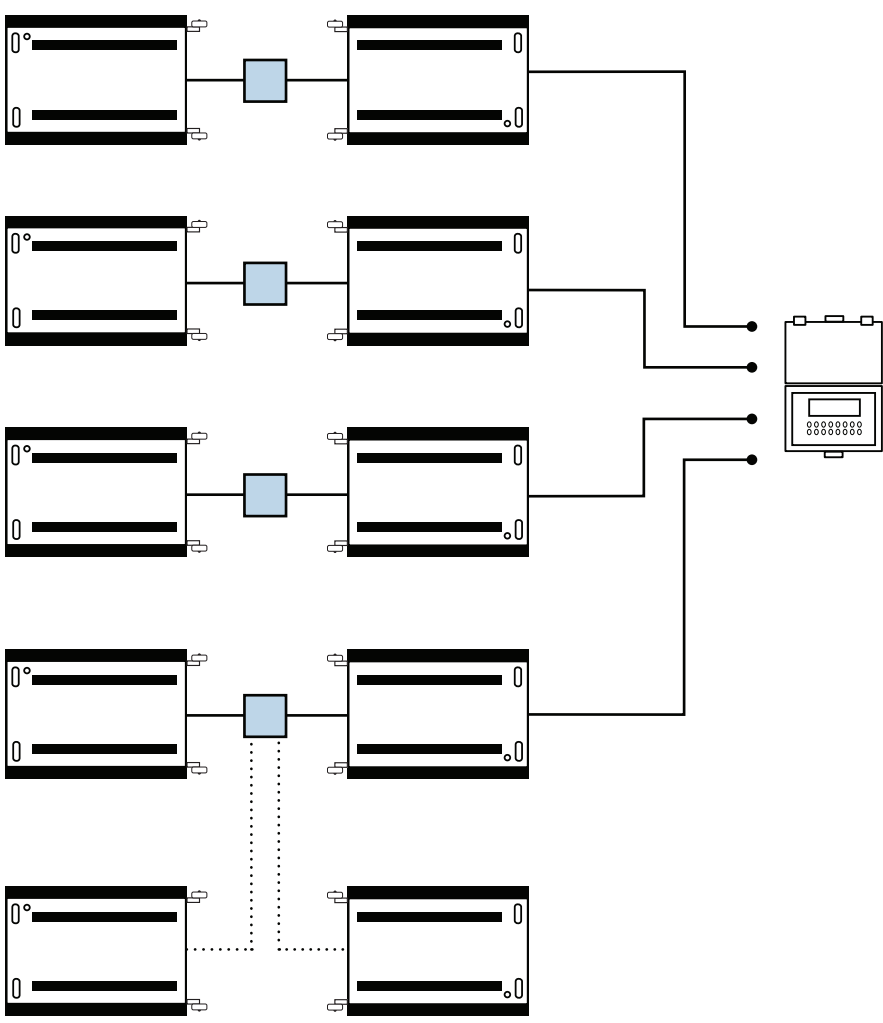

**i** Available both in a wired and wireless version.

 = Junction box

## Over 10 platforms (wireless version only)

### APPLICATIONS

Weighing vehicles with several axles or structures featuring several support points in a single step.

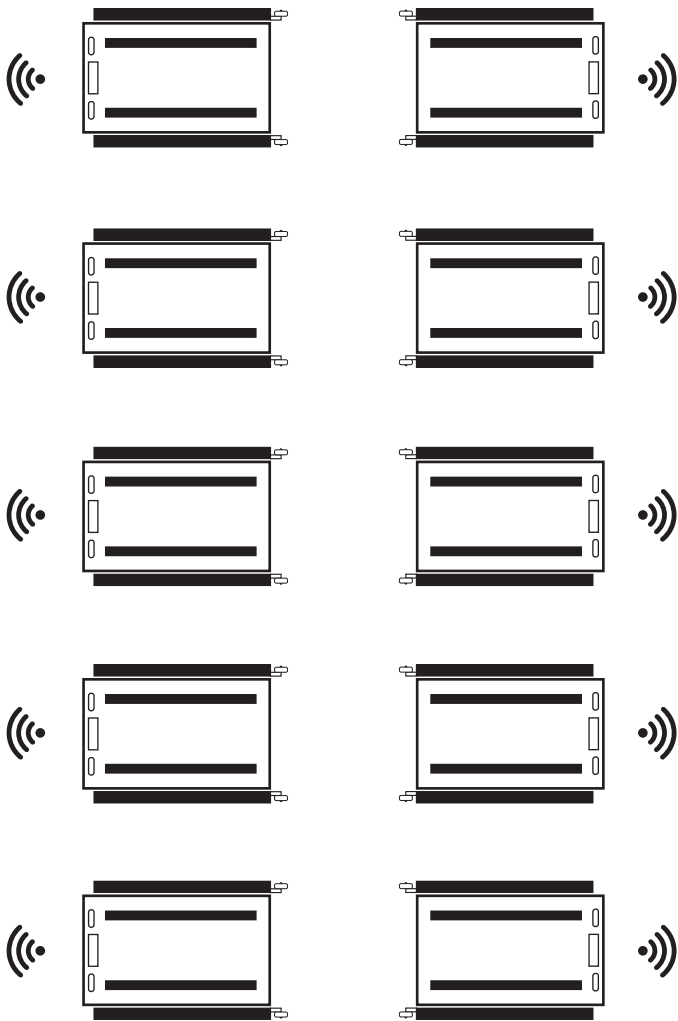

*i*

This setup is used to manage up to 16 platforms.

*i* For weighing vehicles or special structures that might influence wireless communication (shielding effect), we recommend using the “dual” setup in order to concentrate the communication on only one side of the main indicator.

A diagram illustrating a "dual" setup. It shows two platforms connected by a horizontal line. To the right of the second platform is a wireless signal icon. Further to the right is a mobile device icon (a smartphone or tablet) with a wireless signal icon next to it.

## Single “dual” setup

### APPLICATIONS

Specific setup for operation with a tablet or smartphone.



## Choosing the weighing area

### RECOMMENDATIONS FOR AN OPTIMAL SYSTEM INSTALLATION

WWS platforms can be installed on any type of surface, for optimal results we recommend:

- Choosing a weighing area that is large enough to allow easy manoeuvres for vehicles under 100% safe conditions.
- Prefer flat and well-levelled surfaces, with a slope of less than 0.5% and a minimum length equal to twice that of the longest vehicle to be weighted; flat surfaces with an unsuitable length can affect the accuracy of the weighing process.
- Prefer use on hard surfaces, concrete or asphalt with a hardness of at least 100 kg/cm<sup>2</sup> (usual value for reinforced concrete).
- The bottom surface under the weighing area must withstand, without any failures, concentrated loads of at least 1.5 times the maximum capacity of the module.
- Prefer environments where the temperature is between -10°C and +40°C.
- We recommend creating a dedicated area with guardrails or other solutions forcing the driver to transit at a reduced and constant speed. Where possible, install access barriers to prevent transit during periods when the system is not used.

### WARNINGS

- Avoid rough terrain or uneven surfaces.
- Avoid areas at risk of flooding.
- Avoid common transit areas: WWS platforms are not designed to be used as road surfaces and, therefore, they must only be used at the time of weighing according to the conditions stated on (see page 14).

### FEATURES OF THE SURFACE

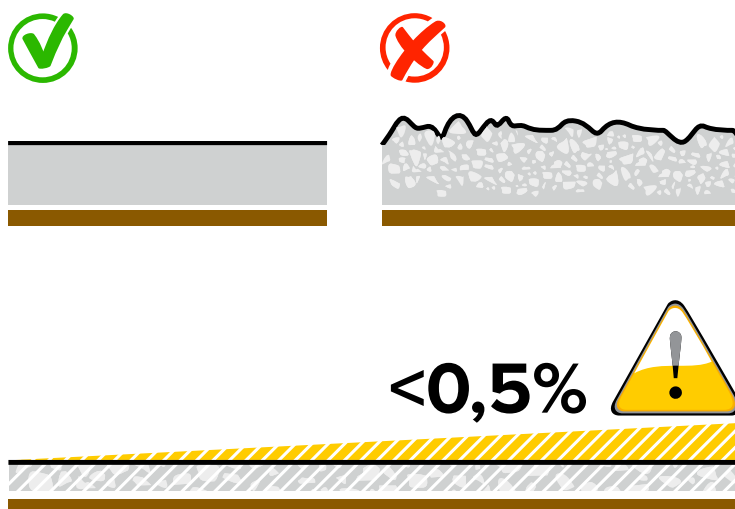

*i*

- In “axle-weighing” mode, we first recommend creating a well-levelled area and then the weighing platforms, which must be of a suitable length.
- In “axle-weighing” mode, we do not recommend weighing vehicles carrying liquids.
- The weighing performance can be affected by the type and state of maintenance of the vehicle weighed.
- Once you have optimised the system, we recommend always keeping the same direction of travel.

*i*

The **levelled area** is required when you need to weigh vehicles with more than two axles. In any case, it is advisable in all axle weighing applications to ensure top performance levels. To create the levelled area, there are **levelling modules** available (see page 16) or the pit frame to fix the platforms flush with the floor (see page 17).

## How to position the platforms

To make the positioning and adjustment of the platforms easier, you can use the built-in wheels:

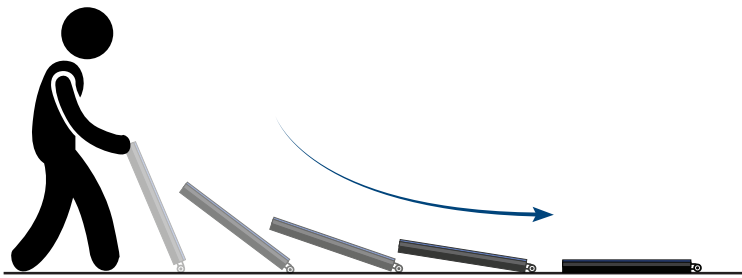

Keep your back straight when lifting the platforms.



To speed up operations without taking measurements, we recommend positioning the platforms directly in front of the wheels of the vehicle to be weighed:

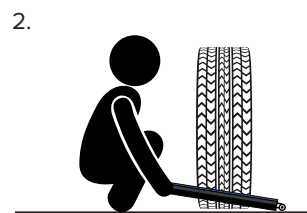
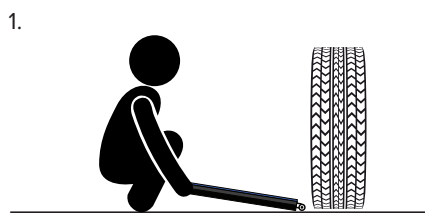

Pay the upmost attention to your hands and feet when positioning the platforms.



When installing the scale, we recommend wearing gloves and work shoes.

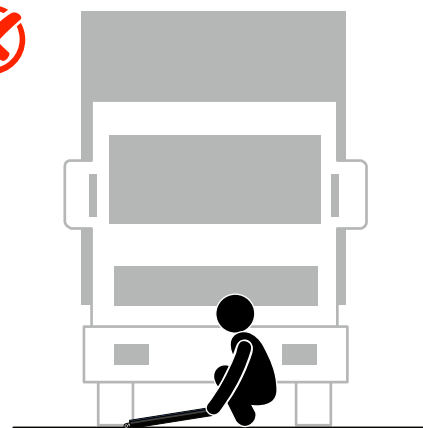
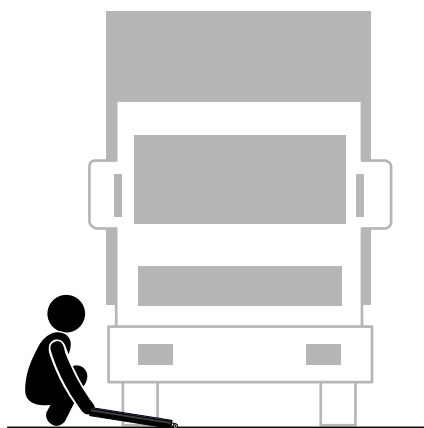

- Before positioning the platforms, ensure that the vehicle's engine is off, with the first gear engaged and the parking brake activated.
- Never stand in front or behind the vehicle during positioning operations.
- Pay the utmost attention to the vehicle when it is moving.

## How to position and connect the cables

Also ensure you do not pass cables in transit areas, under the load cells and under the central box of the platform.



● = Position of the cable

 We recommend placing the cables as follows

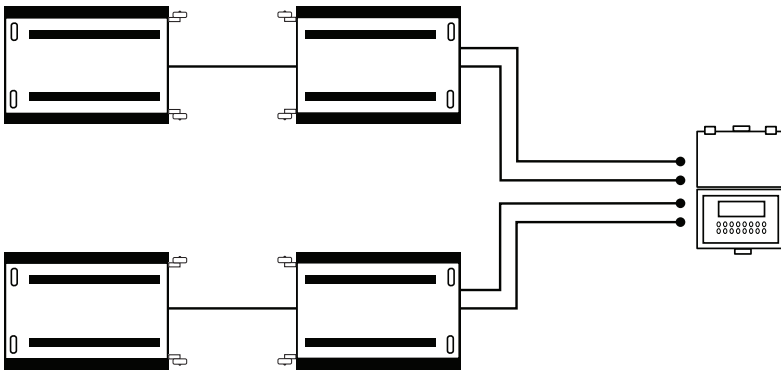

 The connection of the cables must comply with the numbering shown on the connectors

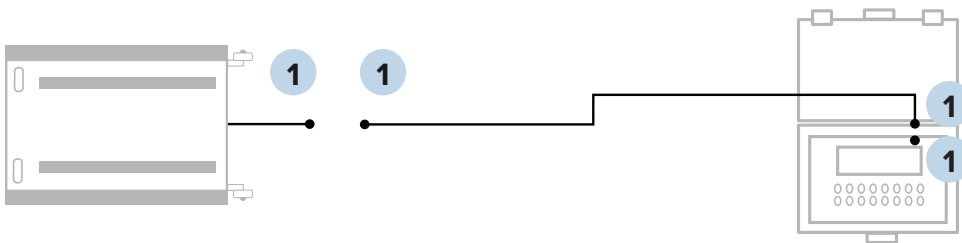

## How to position the wireless platforms

- In case of platforms with a built-in indicator, the indicator must be facing outwards to allow for a correct transmission of detected weighing data.
- The built-in antenna must be facing upwards.
- Do not pass with the vehicle over the screen of the platform.

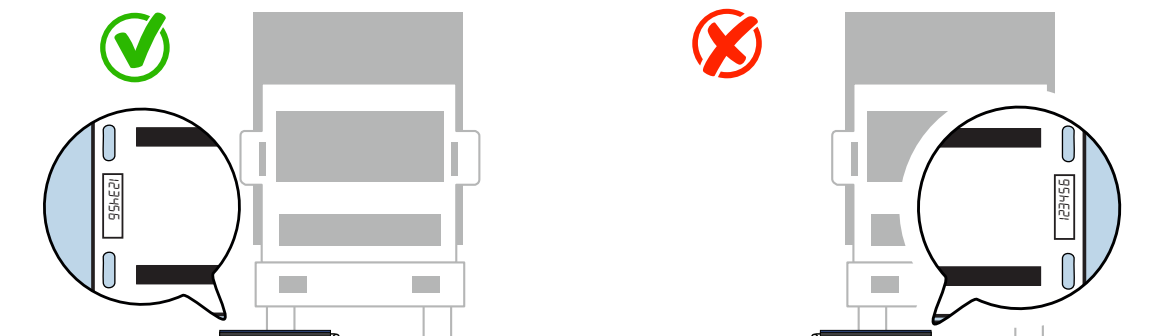

## How to use the platforms correctly

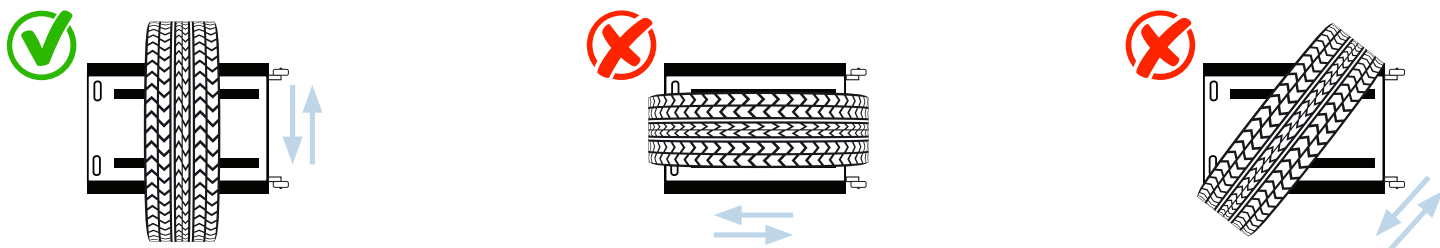

Transit area

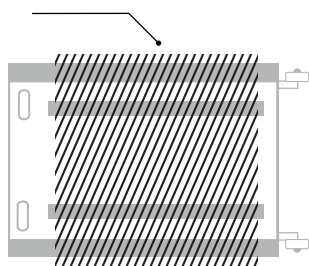

Positioning bands

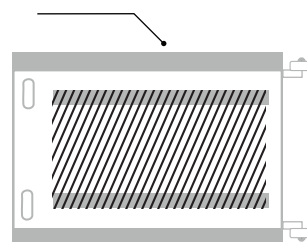

In case of wireless platforms, to preserve the correct operation of the built-in weight indicator, we recommend avoiding transit over the display, thereby preventing accidental scratches. Respect the transit area and positioning indicated in the previous drawing.

## Checking the correct operation of the scales

We recommend periodically checking the correct operation of the platforms to ensure accuracy over time. This is checked with sample weights by specialist personnel to obtain an official calibration certificate. You can also easily check the operation of the platforms yourself by proceeding as follows:

Place one (1) or two (2) platforms on the edge of the weighbridge and proceed with the weighing of individual wheel or the first axle. Make sure the weights displayed by the two systems correspond.

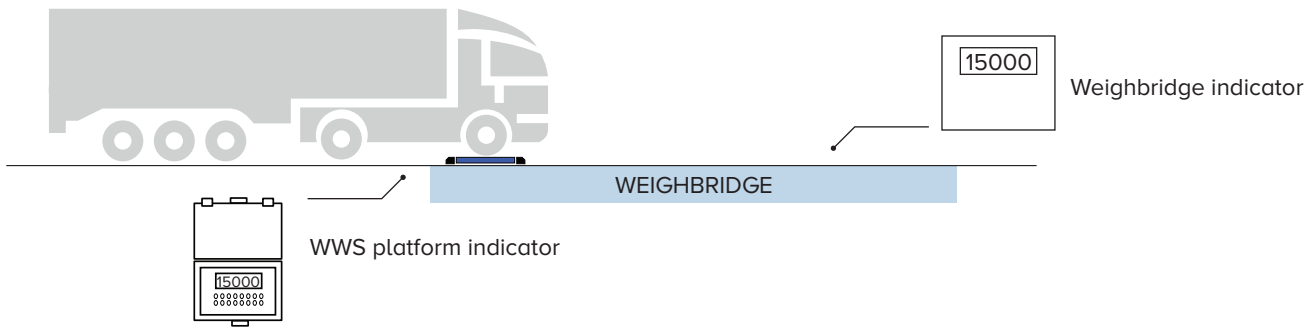

### 1. Single platform test

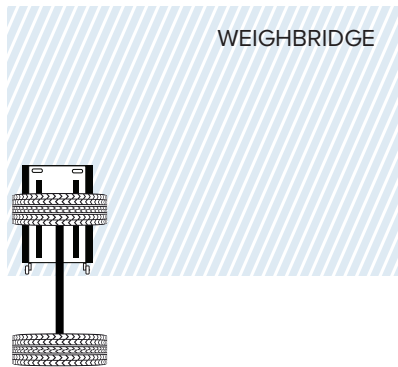

### 2. Axle test

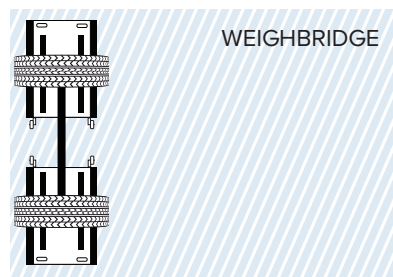

## Periodical maintenance and cleaning of the weighing area

- Remove from the weighing area and the area under the WWS platform any debris that may prevent the loading surface from bending correctly.
- Clean the platform with non-aggressive substances.
- Periodically check the condition of the connection cables.
- In case of prolonged non-use, we recommend fully charging the battery before putting away the system.



## Levelling modules for axle-weighing systems

<b>USE</b>	They are used to create weighing lanes according to the desired length to align all the wheels of the weighted vehicle, thereby considerably improving the weighing accuracy. This also improves the quality of transit surface and reduces the uneven nature of the ground.
<b>APPLICATIONS</b>	Ideal for mobile axle weighing stations.
<b>ACTIVATION</b>	The levelling modules are optional accessories.

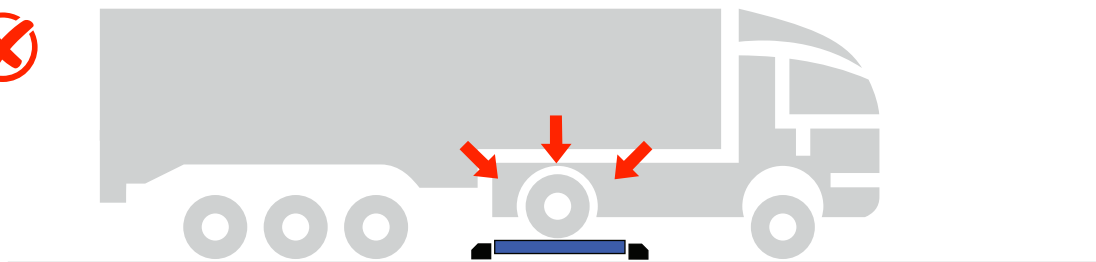
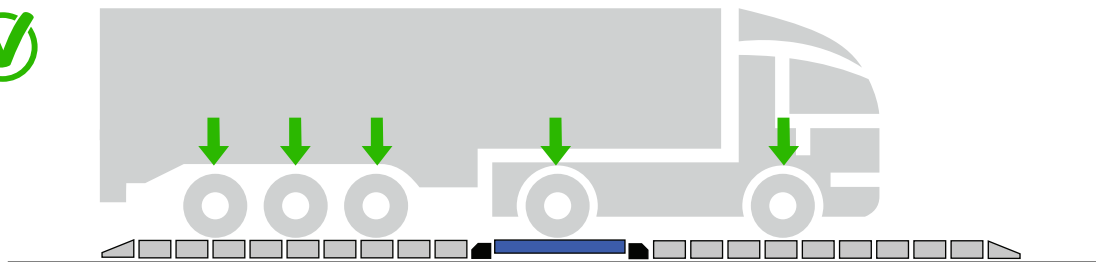

## Choosing the length of the area levelled with the modules

The minimum length of the area depends on the type of vehicle to be weighed. For instance, the recommended length for a 5-axle vehicle is 3.5m before and after the platforms, so as to keep the axles of the engine and those of the trailer at the same level.

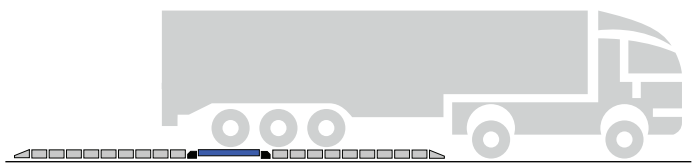
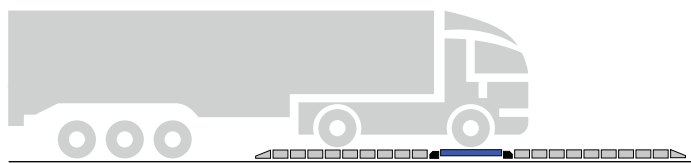

Ideal installation

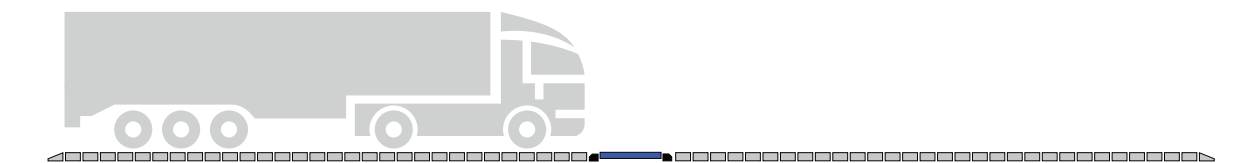

**i**

The best weighing condition is obtained by creating a levelled area whose length is equal to twice that of the longest vehicle to be weighed.

## Pit frames for floor-level installations

<b>USE</b>	They are used to integrate the platforms into the roadbed, thereby improving the distribution of the loads.
<b>APPLICATIONS</b>	Ideal for fixed axle weighing stations.
<b>ACTIVATION</b>	The pit frames are optional accessories.

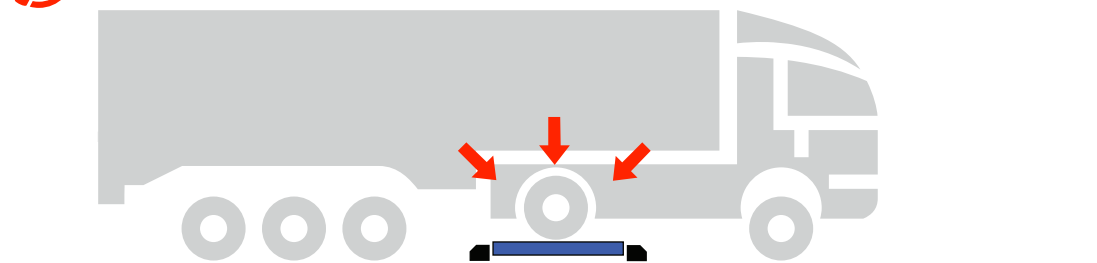
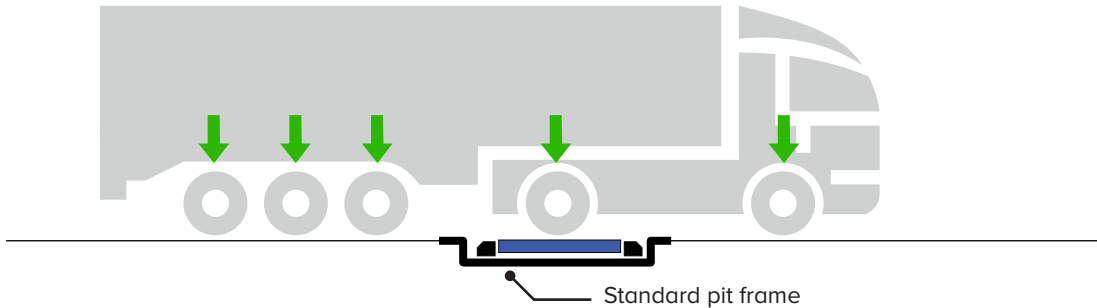

As an alternative to standard pit looms, to achieve greater flexibility in terms of use you can create a pit of an adequate length inside which you can adjust the distance between the platforms, while still keeping them at floor level:

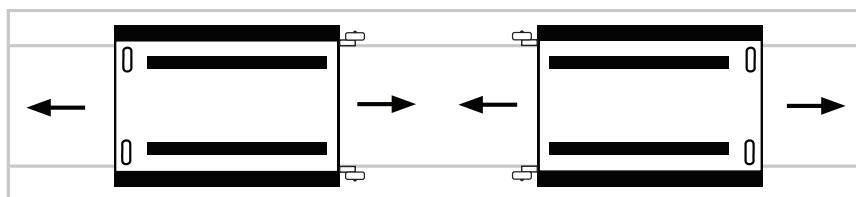

## Additional ramps for easier up/down movements

<b>USE</b>	Used to make it easier to move the platforms up and down.
<b>APPLICATIONS</b>	Ideal for vehicles with wheels featuring a particularly small diameter or for vehicles/aircraft moved with towing equipment.

1.

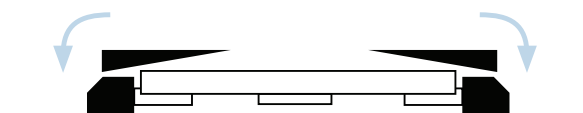

2.

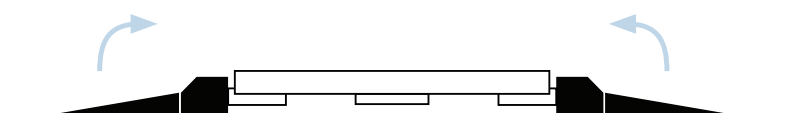

## Weighing of objects or structures

Thanks to their modularity, these handy platforms can be moved in any position, directly below the point in which the structure must be weighed. To use them correctly, please follow this procedure:

1. Lower the load up to an approximate height of 10 cm from the ground

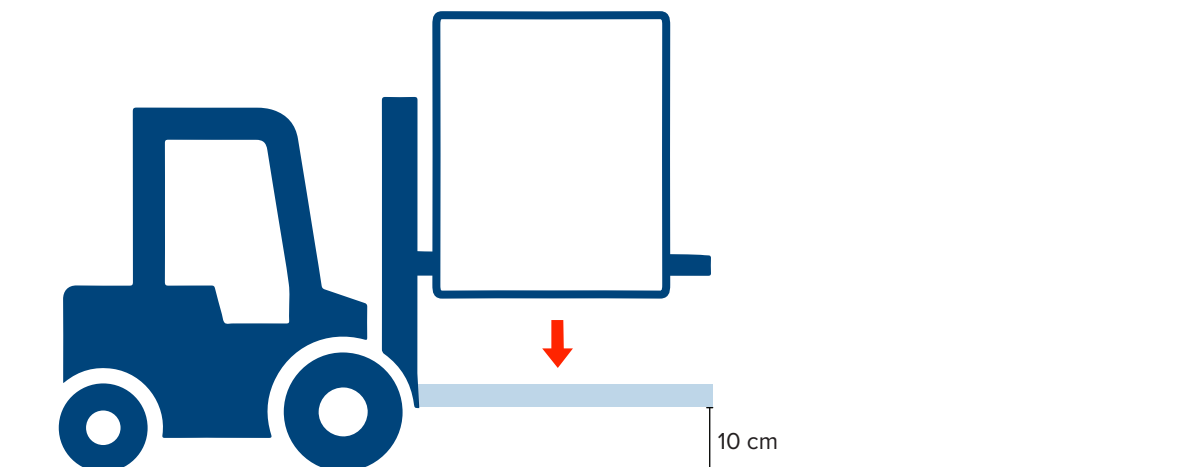

2. Position the load over the platforms



3. Lay the load **slowly** on the platforms



Avoid:

- Sharp manoeuvres
- Rapid lowering of the load
- Accidental crashes on/to the platforms

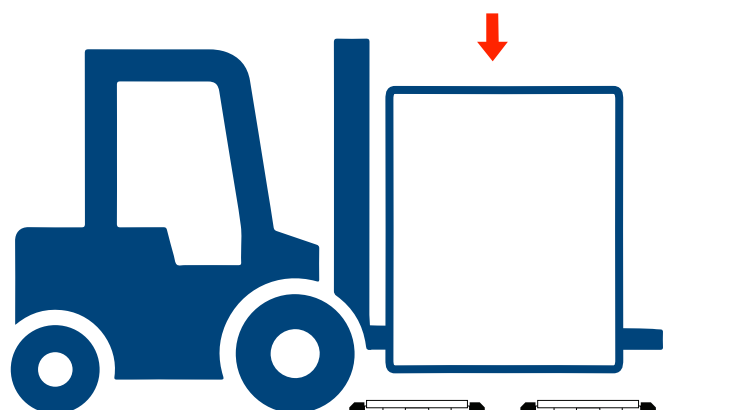

*i*

With wireless platforms:

- If the platforms have an integrated indicator, this must point towards the external side, in order to allow a correct transmission of the weight reading data.
- The integrated antenna must point upwards.
- Do not position the load on the platform screen.

## Communication problems in wireless systems

- Ensure no other devices communicate on the same frequency
- Move the tool on the platforms
- Ensure there are no obstructions between the indicator and the platforms
- Turn the indicator outwards and the radio antennas upwards
- Reload all the platforms and indicators
- Ensure there are no systems on the same frequency.

## How to increase the accuracy of an axle-weighing system

The weighing accuracy in axle-weighing mode is influenced by several factors:

- Type of weighing area must comply with the levelling conditions. *See page 12.*
- Remove any unevenness between the axles by using the levelling modules or pit frames.
- Vehicles with several axles close to each other require a surface that is levelled correctly. *See page 17.*
- Type of vehicle: vehicles with self-levelling suspensions can affect the weighing process; disable them if possible.
- Transported load: the axle weighing process does not allow you to weigh vehicles that carry liquids.
- Follow all the instructions in this manual to obtain optimal weighing results.
- If the system has been optimised for a direction of travel, using it in other direction might reduce the weighing accuracy.

## The scale will bend when loaded

- The bending of the loaded weighing surface makes the operation of the load cells easier, thereby ensuring optimal weighing accuracy. Before installing the platforms, always remove any dirt and debris from the floor under the platform.

## The keypad is locked / the platform does not turn off

- If the automatic keypad lock function has been activated, you cannot do anything on the keyboard, including turning off the platform. *See page 5* to reactivate the keypad.

# Messages and errors

## Messages of the wireless platforms

MESSAGE	DESCRIPTION
PL 1 PL 2 PL 3 PL 4 ...	If the WWS radios are type-approved, the display shows the platform number (instead of weight).
Zero	Weight reset in progress. If the message persists, contact our technical support.
Er . flat	Unstable weight when acquiring a point during calibration.
undEr (blinking)	Weighing error. Unload the platform, turn the system off and turn on. If the problem persists, contact our technical support.
oUEr (blinking)	The weight exceeds the maximum capacity. Immediately remove the load and check that the platform has not been damaged.

# Note

---

---

---

---

---

---

---

---

---

---

---

---

---

---

---

---

---

---

---

---

---

---

---

---

---

---

---







#### **HEAD OFFICE**

Via Della Fisica, 20  
41042 Spezzano di Fiorano, Modena - Italy  
Tel. +39.0536 843418 - Fax +390536 843521  
info@diniargeo.com

#### **SERVICE ASSISTANCE**

Via Dell'Elettronica, 15  
41042 Spezzano di Fiorano, Modena - Italy  
Tel. +39.0536 921784 - Fax +390536 926654  
service@diniargeo.com